

# AN-EVALSF3-ICE3BS03LJG

60W 16V SMPS Evaluation Board with F3  
controller ICE3BS03LJG

Power Management & Supply



N e v e r   s t o p   t h i n k i n g .

**Edition 2007-11-14**

**Published by Infineon Technologies Asia Pacific,  
168 Kallang Way,  
349253 Singapore, Singapore**

**© Infineon Technologies AP 2007.  
All Rights Reserved.**

**Attention please!**

The information herein is given to describe certain components and shall not be considered as a guarantee of characteristics.

Terms of delivery and rights to technical change reserved.

We hereby disclaim any and all warranties, including but not limited to warranties of non-infringement, regarding circuits, descriptions and charts stated herein.

**Information**

For further information on technology, delivery terms and conditions and prices please contact your nearest Infineon Technologies Office ([www.infineon.com](http://www.infineon.com)).

**Warnings**

Due to technical requirements components may contain dangerous substances. For information on the types in question please contact your nearest Infineon Technologies Office.

Infineon Technologies Components may only be used in life-support devices or systems with the express written approval of Infineon Technologies, if a failure of such components can reasonably be expected to cause the failure of that life-support device or system, or to affect the safety or effectiveness of that device or system. Life support devices or systems are intended to be implanted in the human body, or to support and/or maintain and sustain and/or protect human life. If they fail, it is reasonable to assume that the health of the user or other persons may be endangered.





Table of Contents		Page
<b>1</b>	<b>Abstract</b> .....	<b>5</b>
<b>2</b>	<b>Evaluation Board</b> .....	<b>5</b>
<b>3</b>	<b>List of Features</b> .....	<b>7</b>
<b>4</b>	<b>Technical Specifications</b> .....	<b>7</b>
<b>5</b>	<b>Circuit Diagram</b> .....	<b>8</b>
<b>6</b>	<b>PCB Layout</b> .....	<b>9</b>
6.1	Component side component legend.....	9
6.2	Solder side copper & component legend.....	9
<b>7</b>	<b>Circuit Description</b> .....	<b>11</b>
7.1	Introduction.....	11
7.2	Line Input.....	11
7.3	Start up.....	11
7.4	Operation mode.....	11
7.5	Soft start.....	11
7.6	Clamper circuit.....	11
7.7	Main switcher.....	11
7.8	Gate drive.....	11
7.9	Peak current control of primary current.....	12
7.10	Output Stage.....	12
7.11	Feedback and regulation.....	12
7.12	Blanking Window for Load Jump.....	12
7.13	Active Burst Mode.....	12
7.14	Jitter mode.....	13
7.15	Protection modes.....	13
<b>8</b>	<b>Component List</b> .....	<b>14</b>
<b>9</b>	<b>Transformer Construction</b> .....	<b>15</b>
<b>10</b>	<b>Test Results</b> .....	<b>16</b>
10.1	Efficiency.....	16
10.2	Input Standby Power.....	17
10.3	Line Regulation.....	18
10.4	Load Regulation.....	19
10.5	Max. Overload Output Power.....	19
<b>11</b>	<b>Waveforms and Scope Plots</b> .....	<b>20</b>
11.1	Startup @ Low and High AC Line Input Voltage and 60W load.....	20
11.2	Drain Source Voltage and Current during 60W load Operation.....	20
11.3	Load Transient Response (Load jump from 10% to 100% Load).....	21
11.4	AC Output Ripple during 60W.....	21
11.5	Active Burst Mode @ 0.5W load.....	22
11.6	Over load protection – Auto Restart.....	23
11.7	Open loop protection – Auto Restart.....	24
11.8	Short optocoupler – Auto Restart.....	24
11.9	Vcc overvoltage protection - Latched Off.....	25
11.10	External latched off enable.....	25
11.11	Frequency Jittering.....	26
<b>12</b>	<b>Appendix</b> .....	<b>27</b>
12.1	Slope compensation for CCM operation.....	27
<b>13</b>	<b>References</b> .....	<b>27</b>

## 1 Abstract

This document is an engineering report that describes a universal input power supply designed in a 16V 60W off line flyback converter that utilizes the F3 controller ICE3BS03LJG. The application board is operated in discontinuous current mode and running at 65 kHz switching frequency. It has one output voltage with secondary side control regulation. It is especially suitable for AC/DC power supply such as LCD monitors, adapters for printers and notebook computers, DVD players and recorder, Blue-Ray DVD player and recorder, set-top boxes and industrial auxiliary power supplies. The ICE3BS03LJG is a current mode PWM controller. With the 500V startup cell, active burst mode and BiCMOS technologies, the standby power can be <math><100\text{mW}</math> at no load. The frequency jitter mode and the soft gate drive can give a low EMI performance. The built-in 20ms blanking window and the extendable blanking time concept can prevent the IC from entering the auto restart mode due to over load protection unintentionally. The outstanding propagation delay compensation feature can allow a very precise current limit between low line and high line. For this IC, it provides both auto-restart and latch off protection mode. For those serious faults such as Vcc over-voltage, over temperature, short transformer winding, etc, the IC will enter the latched off protection mode. For the less severe case such as the over load, open loop, short opto-coupler, etc, it enter the auto restart protection mode. In case it needs customer defined protection, the external latch off enable feature can fulfill the requirement.

## 2 Evaluation Board

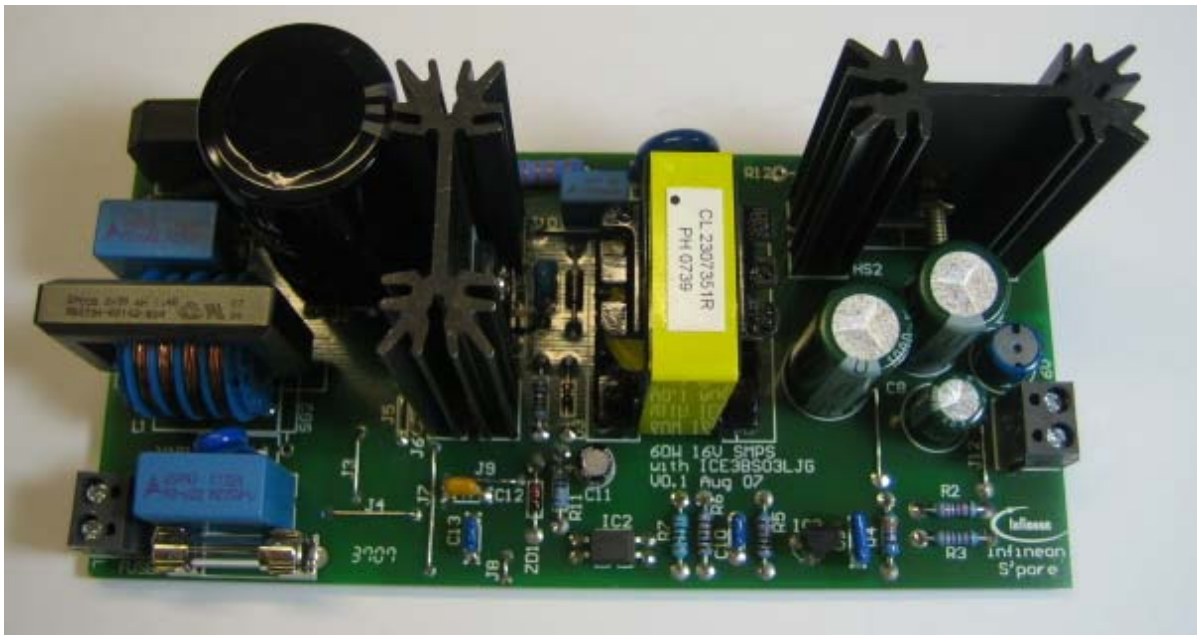
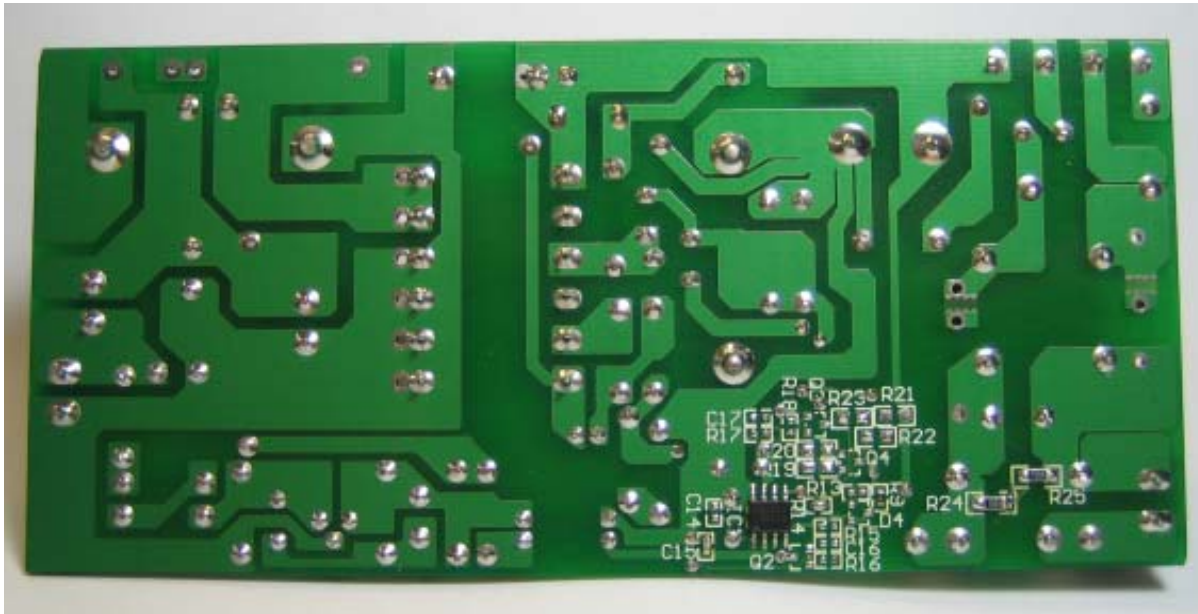

Figure 1a – EVALSF3-ICE3BS03LJG (top view)



**Figure 1b** – EVALSF3-ICE3BS03LJG (bottom view)

This document contains the list of features, the power supply specification, schematic, bill of material and the transformer construction drawing. Typical operating characteristics and performance curves with scope waveforms are presented at the rear of the report.

### 3 List of Features

500V Startup Cell
Active Burst Mode for lowest Standby Power
Fast load jump response in Active Burst Mode
65kHz internally fixed switching frequency
Frequency jitter and soft gate driving for low EMI
Max Duty Cycle 75%
Overall tolerance of Current Limiting < $\pm 5\%$
Internal PWM Leading Edge Blanking
BiCMOS technology provide wide VCC range
Built-in Soft Start
Built-in blanking window with extendable blanking time for short duration high current
Built-in latched Off Protection Mode for Over temperature, Over Voltage & Short Winding
Auto Restart Protection Mode for Over load, Open Loop & VCC Undervoltage
External latch enable function

### 4 Technical Specifications

Input voltage	85VAC~265VAC
Input frequency	50Hz, 60Hz
Input Standby Power	< 100mV @ no load; < 1W @ 0.5W load
Output voltage and current	16V +/- 2%
Output current	3.75A
Output power	60W
Efficiency	>80% at full load
Output ripple voltage	< 100mVp-p ( exclude high frequency spike )





## 6 PCB Layout

### 6.1 Component side component legend

DEMO 60W 16V SMPS WITH ICE3BS03LJG

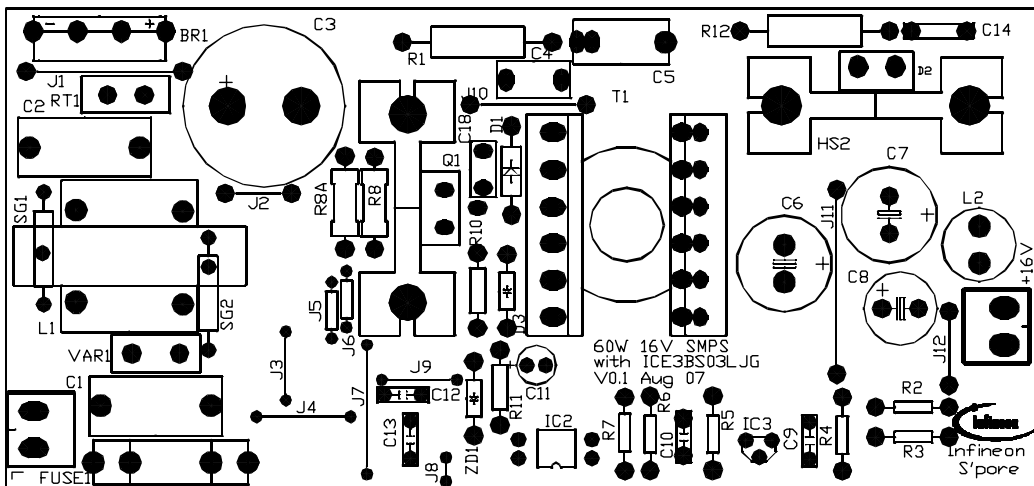

Figure 3 – Component side Component Legend – View from Component Side

### 6.2 Solder side copper & component legend

DEMO 60W 16V SMPS WITH ICE3BS03LJG

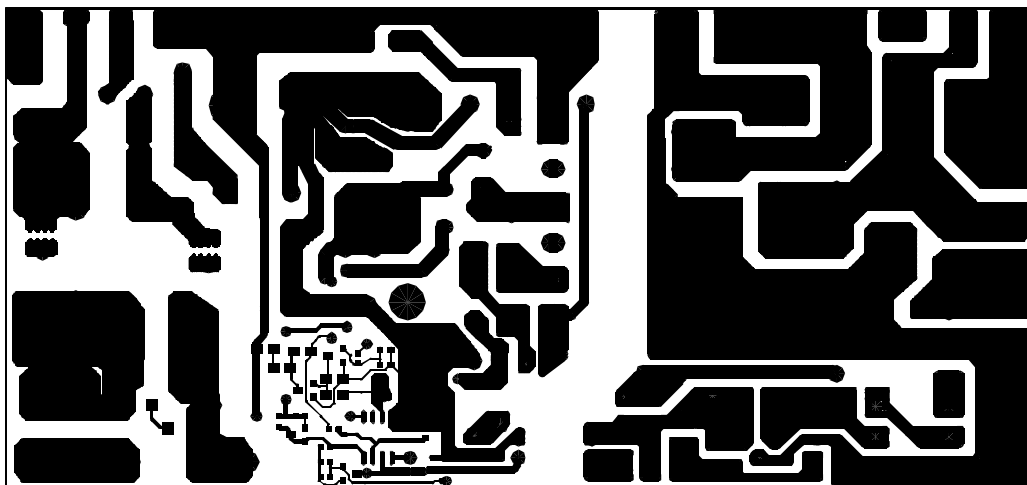

Figure 4 – Solder side copper – View from Component Side

DEMO 60W 16V SMPS WITH ICE3BS03LJG

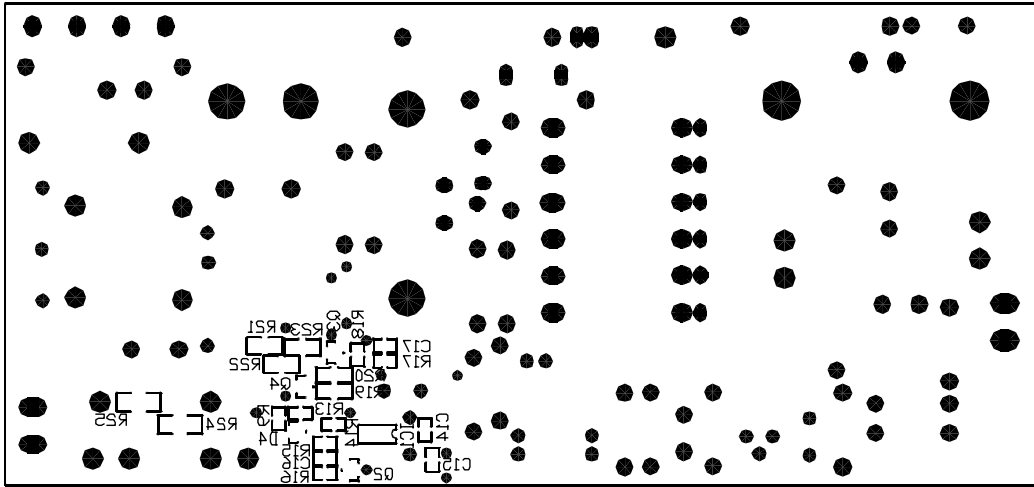

Figure 5 – Solder side component legend – View from Component Side

## 7 Circuit Description

### 7.1 Introduction

The EVALSF3-ICE3BS03LJG demo board is an off line flyback switch mode power supply (SMPS) using the ICE3BS03LJG PWM IC from the Infineon PWM controller. The circuit, shown in Figure 2, details a 16V, 60W power supply that operates from an AC line input voltage range of 85Vac to 265Vac, suitable for applications requiring either an open frame supply or an enclosed adapter.

### 7.2 Line Input

The AC input side comprises the input fuse FUSE1 as over-current protection. The common mode choke L1, X2-capacitors C1 and C2 and Y1-capacitor C5 act as radio interference suppressors. A varistor VAR1 is added to absorb the line transient while a NTC, RT1 is added to reduce the inrush surge current during start up. Two series resistor, R24 and R25 are added to discharge the voltage at C1 and C2 after the AC line is removed. A rectified DC voltage (100V ~ 380V) is obtained through the bridge rectifier BR1 and the input bulk capacitor C3.

### 7.3 Start up

Since there is a built-in startup cell in the ICE3BS03LJG, there is no need for external start up resistors. The startup cell is connecting the HV pin of the IC. Once the voltage is built up at the HV pin of the ICE3BS03LJG, the startup cell will charge up the Vcc capacitor C11 and C12. When the Vcc voltage exceeds the UVLO at 18V, the IC starts up. Then the Vcc voltage is bootstrapped by the auxiliary winding to sustain the operation.

### 7.4 Operation mode

During operation, the Vcc pin is supplied via a separate transformer winding with associated rectification D3 and buffering and filtering capacitors C11 and C12. Resistor R10 is used for current limiting. In order not to exceed the maximum voltage at Vcc pin, an external zener diode ZD1 is added to clamp the voltage.

### 7.5 Soft start

The Soft-Start time is built-in 20ms. After the Vcc hits UVLO at 18V, it starts the soft-start phase.

### 7.6 Clamper circuit

The circuit R1, C4 and D1 clamp the DRAIN voltage spike caused by transformer leakage inductance to a safe value below the drain source break down voltage.

### 7.7 Main switcher

Q1 is the main switcher for the system. It has a low R<sub>dson</sub> to reduce the conduction loss. An optional drain-source capacitor can be added to the MOSFET to reduce the switching noise so as to get a better EMI performance.

### 7.8 Gate drive

The gate drive current is 0.17A push and 0.39A pull. The gate on signal has installed with a slope controlled rising edge feature which make the driving softly. If it needs to optimize the EMI performance, a turn off resistor-diode network can be added in parallel with the gate drive resistor, R13.

## 7.9 Peak current control of primary current

The power MOSFET drain source current is sensed via external shunt resistors R8 and R8A which determine the tolerance of the current limit control. Since ICE3BS03LJG is a current mode controller, it would have a cycle-by-cycle primary current and feedback voltage control which can make sure the maximum power of the converter is controlled in every switching cycle. Besides, a propagation delay compensation is implemented to ensure the maximum input current/power can be controlled in an even tighter manner. The demo board shows app. +/-3% (refer to Figure 12).

## 7.10 Output Stage

The power is coupled to the secondary side through an ultra fast recovery diode D2. The capacitor C6 and C7 provide energy buffering and the cascading LC filter L2 and C8 is used to reduce the output voltage ripple. The capacitor C6 and C7 are selected to have a low internal resistance (ESR) to minimize the output voltage ripple.

## 7.11 Feedback and regulation

The output voltage is controlled by a TL431 reference control IC (IC3). This device incorporates the voltage reference as well as the error amplifier. Compensation network C9, C10, R2, R3 and R5 constitutes the loop compensation circuit. This circuitry allows the feedback to be precisely matched to dynamically varying load conditions and provides stable control. The maximum current through the optocoupler diode and the voltage reference is set by using resistors R6 and R7. Optocoupler IC2 is used to transmit the control signal to the "Feedback" input of the ICE3BS03LJG device. The selected optocoupler should meet DIN VDE 884 requirements for a wider creepage distance.

## 7.12 Blanking Window for Load Jump

In case of Load Jumps the Controller provides a Blanking Window before activating the Over Load Protection and entering the Auto Restart Mode. There are 2 modes for the blanking time setting; basic mode and the extendable mode. If there is no capacitor added to the BL pin, it would fall into the basic mode; i.e. the blanking time is set at 20ms. If a longer blanking time is required, a capacitor, C13 can be added to BL pin to extend it. The extended time can be achieved by an internal 13uA constant current at BL pin to charge C13 from 0.9V to 4.0V. Thus the overall blanking time is the addition of 20ms and the extended time. For example, C13 (external capacitor at BL pin) = 0.1uF,  $I_{BK}$  (internal charging current) = 13uA

Blanking time (total) = 20ms +  $C13 \times (4-0.9)/I_{BK}$  = 43.9ms

Note: A filter capacitor (e.g. 100pF) may be needed to add to the BL pin if the noises cannot be avoided to enter that pin in the physical PCB layout. Otherwise, some protection features may be mis-triggered and the system may not be working properly.

## 7.13 Active Burst Mode

At light load condition, the SMPS enters into Active Burst Mode. At this stage, the controller is always active but the  $V_{CC}$  must be kept above the switch off threshold; i.e.  $V_{CCoff} \geq 10.5V$ . During active burst mode, the efficiency increases significantly and at the same time it supports low ripple on  $V_{OUT}$  and fast response on load jump. When the voltage level at FB falls below 1.23V, the internal blanking timer starts to count. When it reaches the built-in 20ms blanking time, it will enter Active Burst Mode. The Blanking Window is generated to avoid sudden entering of Burst Mode due to load jump.

During Active Burst Mode the current sense voltage limit is reduced from 1V to 0.25V so as to reduce the conduction losses and audible noise. All the internal circuits are switched off except the reference and bias voltages to reduce the total  $V_{CC}$  current consumption to below 0.45mA. At burst mode, the FB voltage is changing like a sawtooth between 3.0 and 3.5V. To leave Burst Mode, FB voltage must exceed 4V. It will reset the Active Burst Mode and turn the SMPS into Normal Operating Mode. The maximum current; i.e. current sense voltage limit resume to 1V, can then be provided to stabilize  $V_{OUT}$ .

### 7.14 Jitter mode

The ICE3BS03LJG has frequency jittering feature to reduce the EMI noise. The jitter frequency is internally set at 65 kHz (+/-2.6 kHz) and the jitter period is set at 4ms.

### 7.15 Protection modes

Protection is one of the major factors to determine whether the system is safe and robust. Therefore, sufficient protection is a must. ICE3BS03LJG provides all the necessary protections to ensure the system is operating safely. There are 2 kinds of protection mode; auto-restart and latch off mode. When there are serious faults such as Vcc over-voltage, over temperature and short winding, it enters the latch off mode. For those less severe faults such as over load, open loop and short optocoupler, it enters the auto-restart mode. In addition, there is an external latch enable feature which is suitable for those tailor-made protection features. A list of protections and the failure conditions are showed in the below table.

Protection function	Failure condition	Protection Mode
Vcc Over-voltage	$V_{CC} > 25.5V$	Latch off
Over-temperature (controller junction)	$T_J > 130^{\circ}C$	Latch off
Short winding / Short diode	$V_{CS} > 1.66V$	Latch off
External Latch off enable	$V_{BL} < 0.25V$	Latch off
Over-load / Open loop	$V_{FB} > 4.0V$ and $V_{BL} > 4.0V$ and after Blanking time	Auto Restart
Vcc Under-voltage / short Opto-coupler	$V_{CC} < 10.5V$	Auto Restart

## 8 Component List

Item	Circuit code	Part Type	Quantity
1	BR1	2A 800V	1
2	C1	0.22uF, 275V	1
3	C10	2.7nF,63V	1
4	C11	22uF, 50V	1
5	C12	0.1uF, 63V	1
6	C13	100pF, 63V	1
7	C15	220pF, 63V	1
8	C2	0.22uF, 275V	1
9	C3	150uF, 400V	1
10	C4	10n, 400V	1
11	C5	2.2nF, 250V	1
12	C6	1000uF, 35V	1
13	C7	1000uF, 35V	1
14	C8	220uF, 25V	1
15	C9	0.68uF, 63V	1
16	D1	UF4006	1
17	D2	MUR1520	1
18	D3	1N4148	1
19	FUSE1	4A 250V	1
20	IC1	ICE3BS03LJG, SO-8	1
21	IC2	SFH617	1
22	IC3	TL431	1
23	J1 ~ J12	Jumper	12
24	L1	39mH, 1.4A	1
25	L2	1uH	1
26	Q1	SPA07N60C3	1
27	R1	33K, 2W	1
28	R10	100R, 1/4W	1
29	R11	47R, 1/4W	1
30	R14	0R, 0603	1
31	R2	22K, 1%, 1/4W	1
32	R24	1M, 1206	1
33	R25	1M, 1206	1
34	R3	1.2K, 1%, 1/4W	1
35	R4	4.3K, 1%, 1/4W	1
36	R5	10K, 1/4W	1
37	R6	1K, 1/4W	1
38	R7	750R, 1/4W	1
39	R8	0.56R, 1/2W	1
40	R8A	0.56R, 1/2W	1
41	R9	3R3, 1/4W	1
42	RT1	NTC 2.5Ohm	1
43	T1	ER28L,N87, Lp=154uH	1
44	VAR1	0.25W 275V	1
45	ZD1	24V 0.5W	1

## 9 Transformer Construction

Core and material : ER28, N87 or EER28L, PC40

Bobbin: Vertical type

Primary Inductance,  $L_p = 154\mu\text{H}$  measured between pin 3 and pin 1 (Gapped to Inductance)

### Transformer structure:

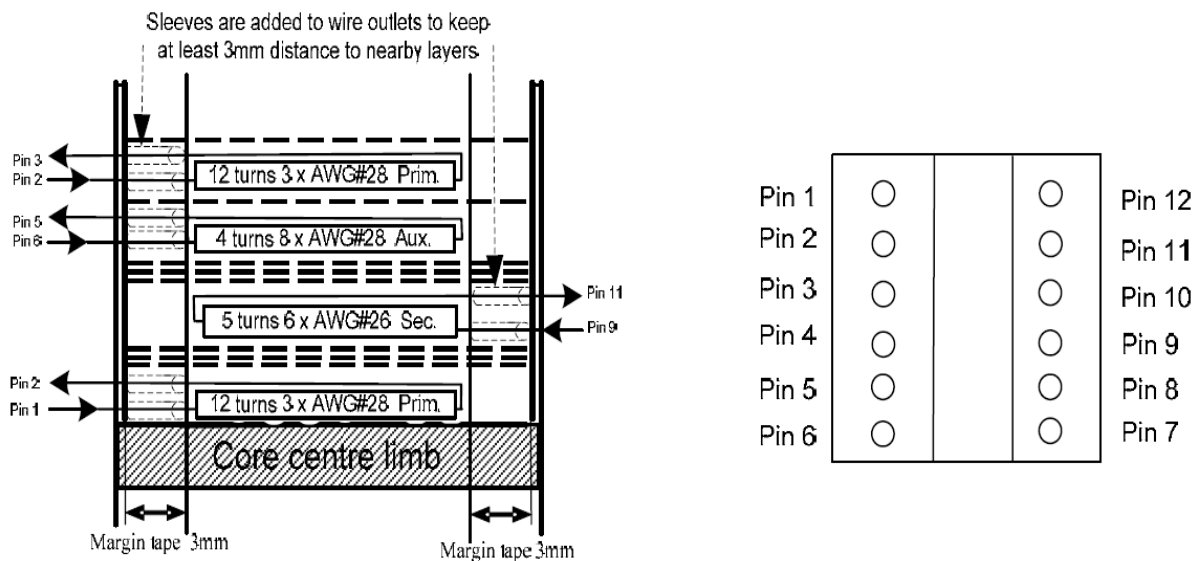

Figure 5 – Transformer structure and top view of transformer complete

### Wire size requirement:

Start	Stop	No. of turns	Wire size	layer
2	3	12	3x0.3mm ( AWG#28 )	½ Primary
6	5	4	8X0.3mm ( AWG# 28)	Auxiliary
9	11	5	6X0.4mm ( AWG#26 )	Secondary
1	2	12	3x0.3mm ( AWG#28 )	½ Primary

## 10 Test Results

### 10.1 Efficiency

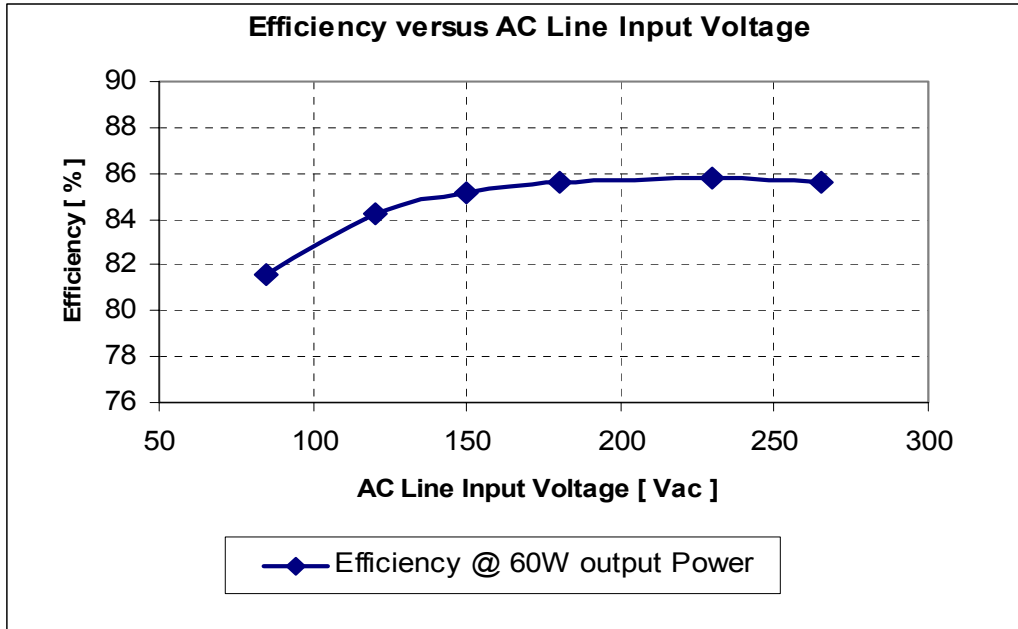

Figure 6 – Efficiency vs. AC Line Input Voltage

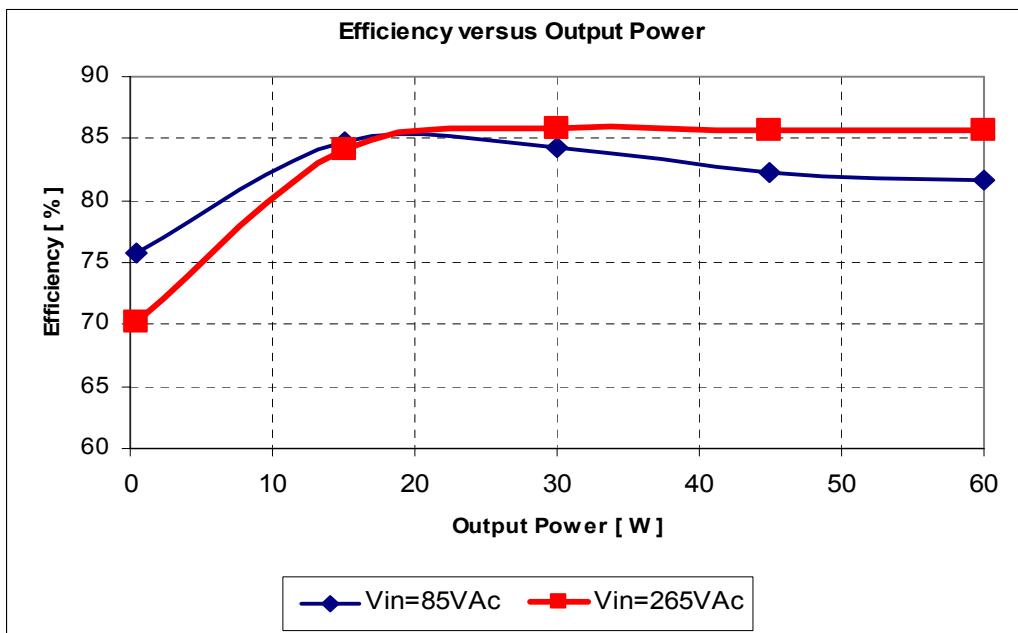
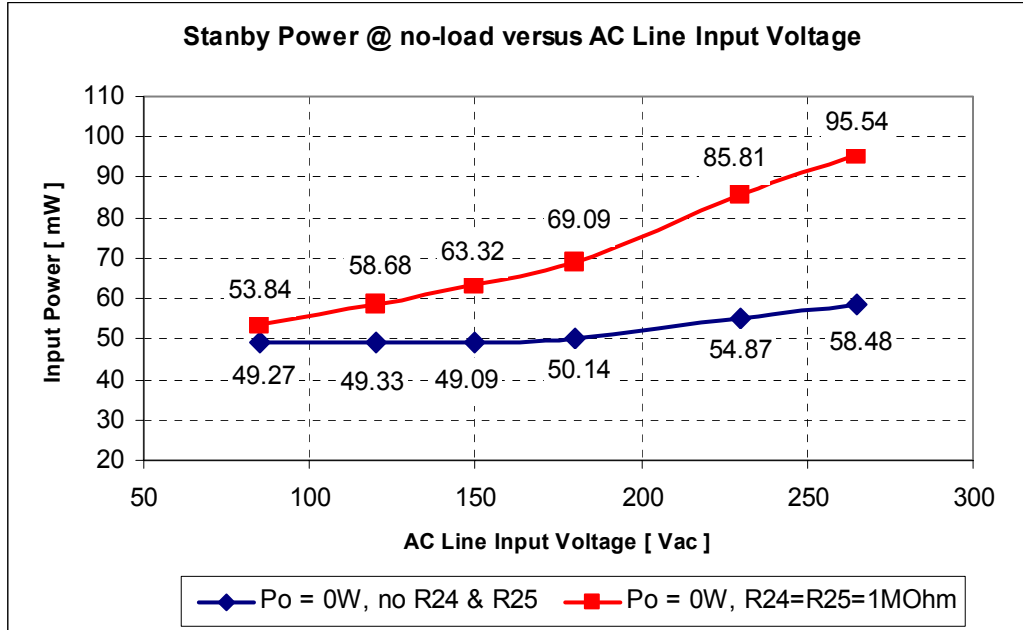

Figure 7 – Efficiency vs. Output Power @ Low and High Line 50Hz



## 10.2 Input Standby Power



**Figure 8** – Input Standby Power @ no load vs. AC Line Input Voltage  
( Equipment : Yokogawa WT210 power meter – using integration mode )

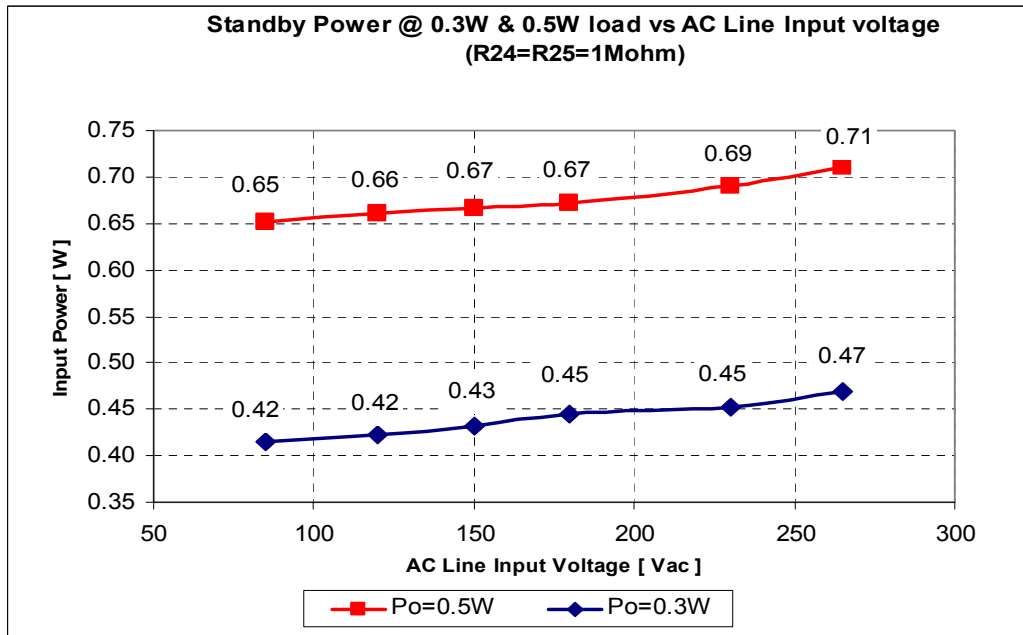

**Figure 9** – Input Standby Power @ 0.3W & 0.5W load vs. AC Line Input Voltage  
( Equipment : Yokogawa WT210 power meter – using integration mode )

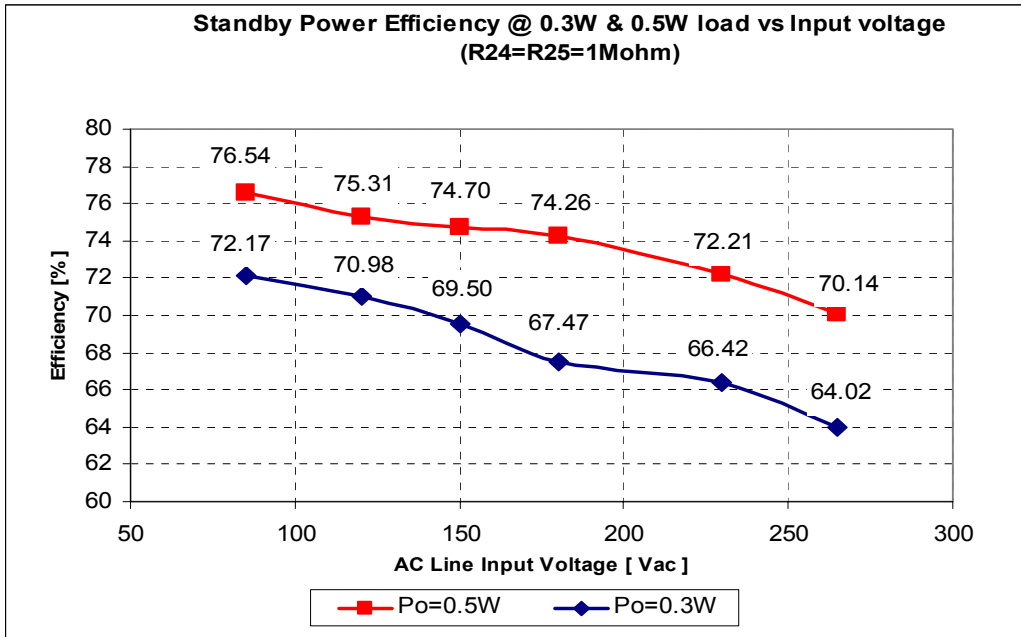

Figure 10 – Standby Power Efficiency @ 0.3W & 0.5W load vs. AC Line Input Voltage

### 10.3 Line Regulation

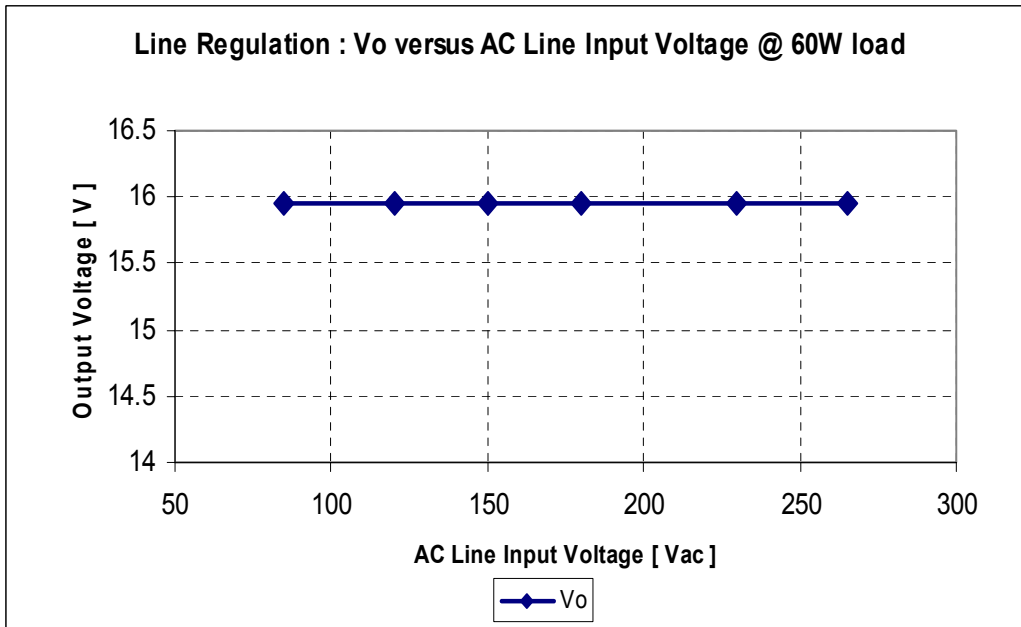

Figure 11 – Line Regulation vs. AC Line Input Voltage

### 10.4 Load Regulation

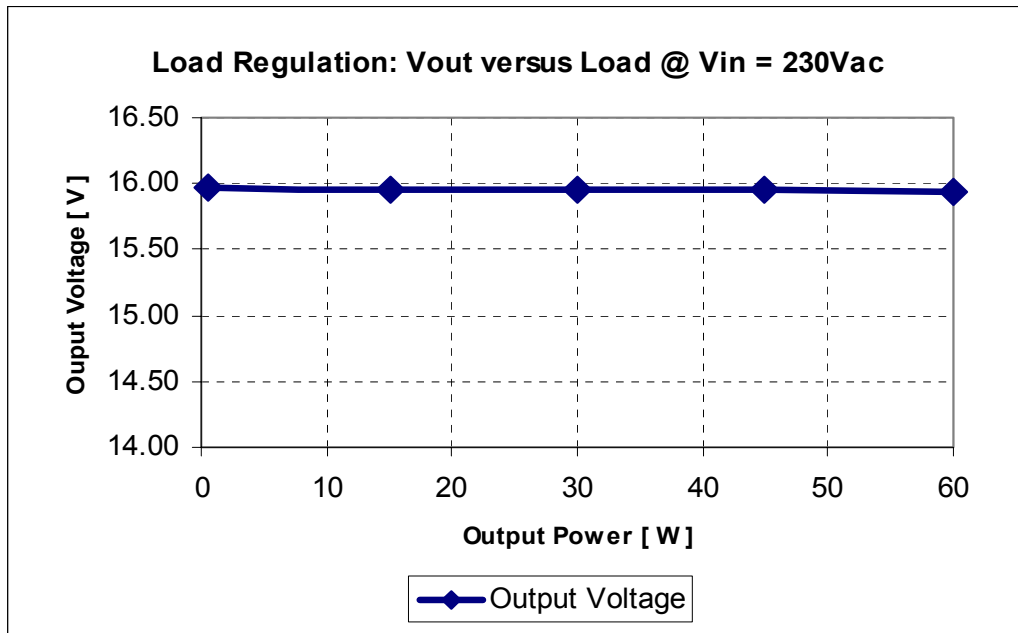

Figure 12 – Load Regulation vs. AC Line Input Voltage

### 10.5 Max. Overload Output Power

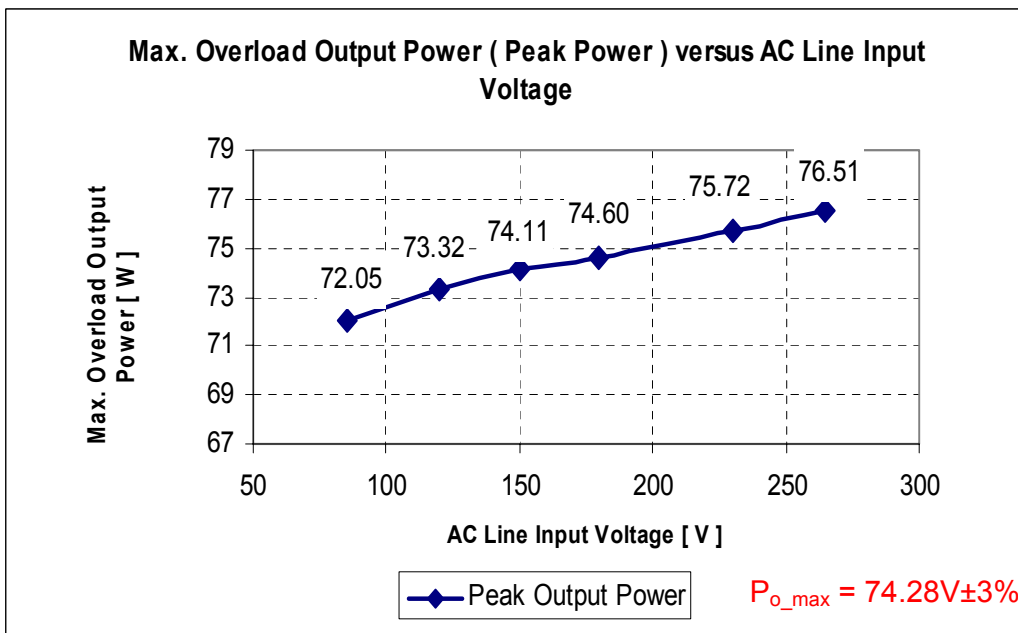
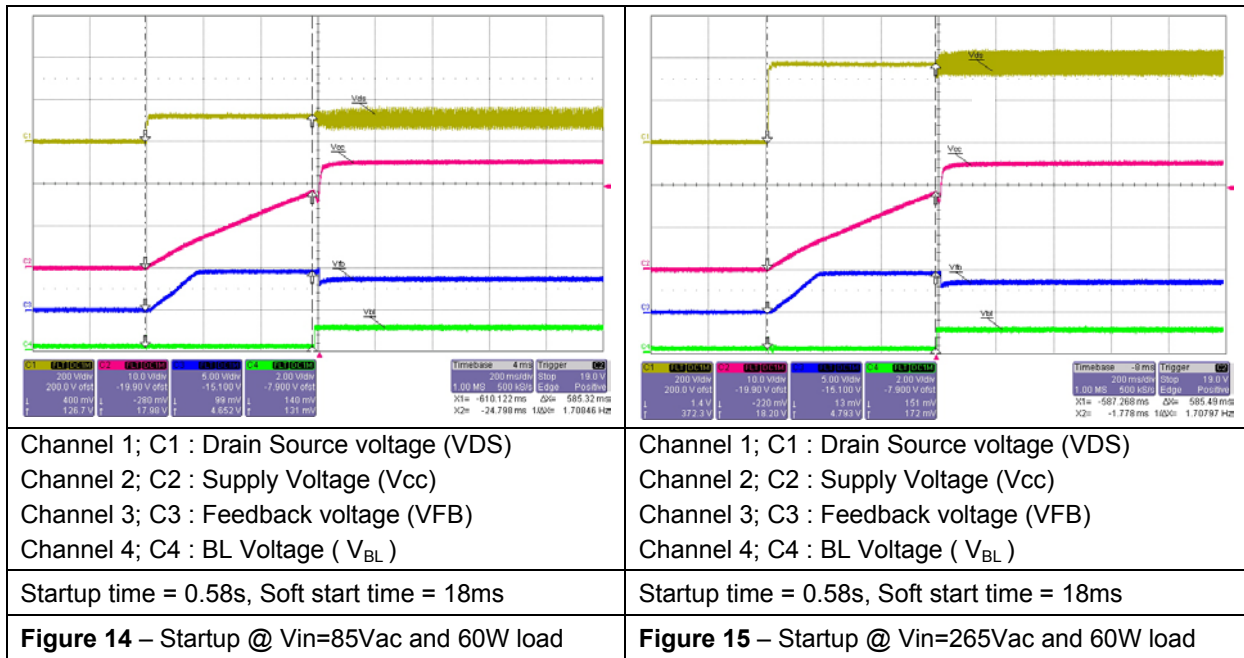

Figure 13 – Overload Output Power (Over Current Shut Off Threshold) vs. AC Line Input Voltage

## 11 Waveforms and Scope Plots

All waveforms and scope plots were recorded with a LeCroy 6050 oscilloscope

### 11.1 Startup @ Low and High AC Line Input Voltage and 60W load



### 11.2 Drain Source Voltage and Current during 60W load Operation

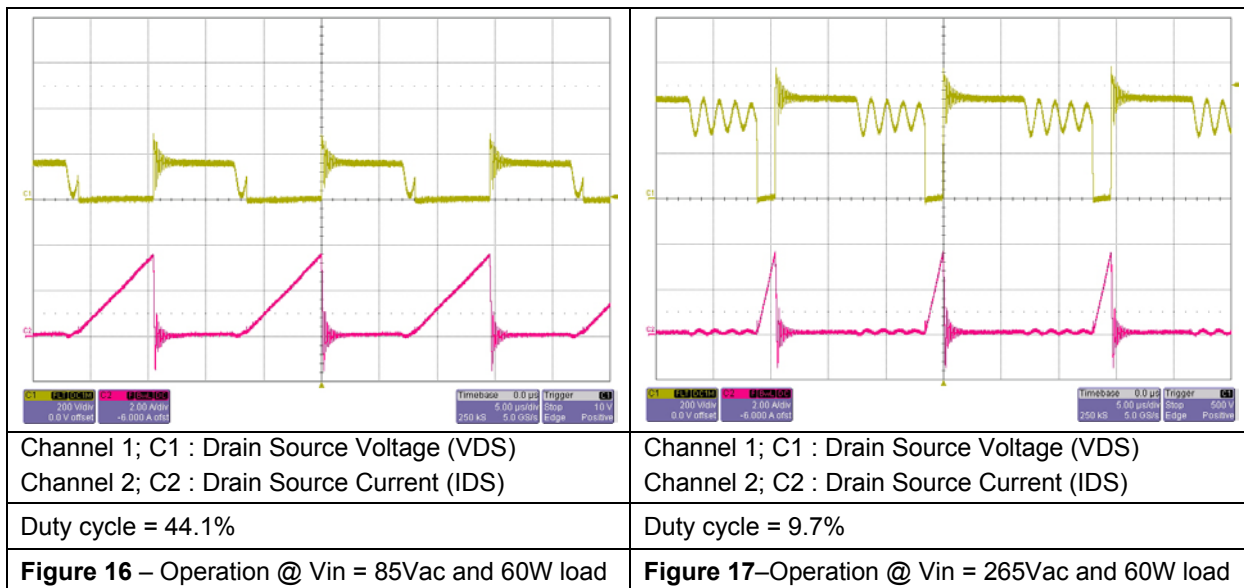

### 11.3 Load Transient Response (Load jump from 10% to 100% Load)

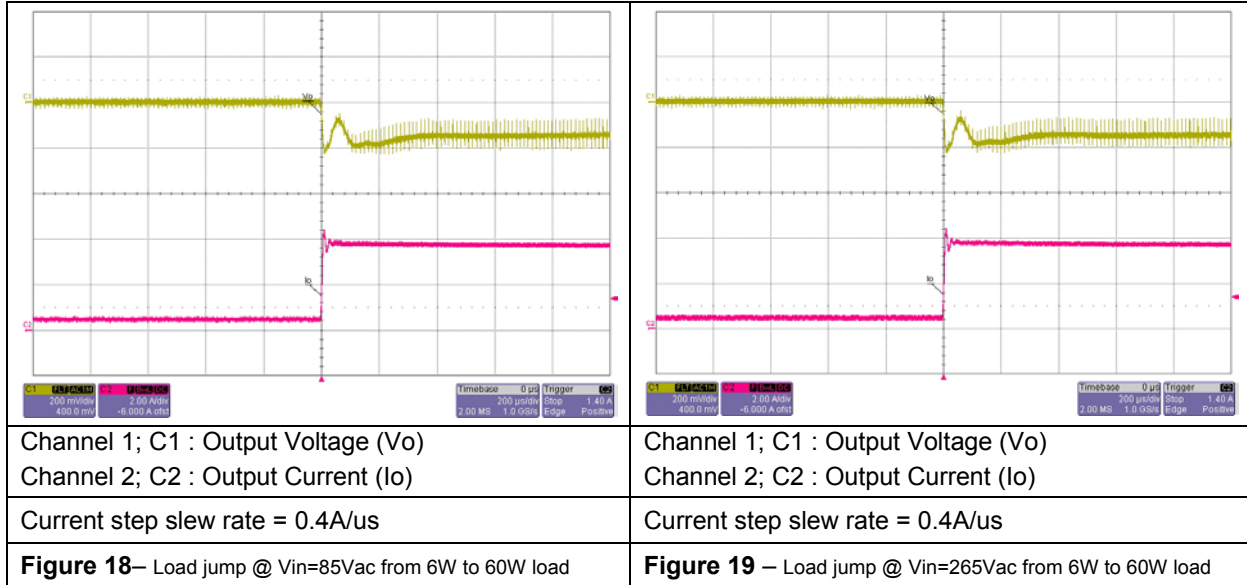

### 11.4 AC Output Ripple during 60W

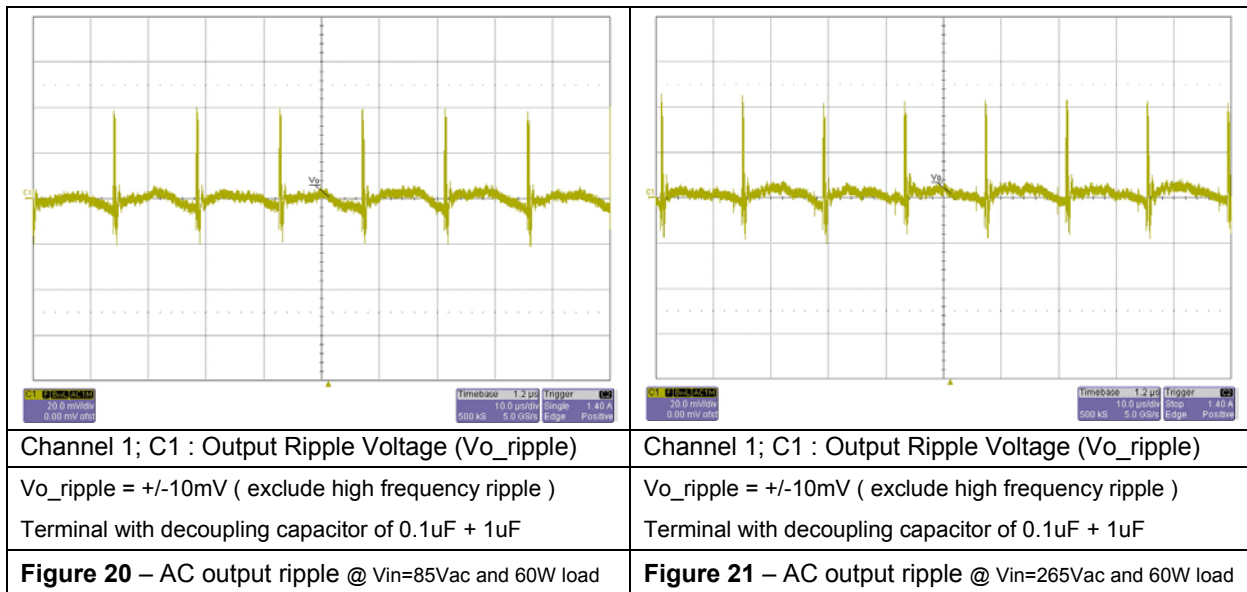

11.5 Active Burst Mode @ 0.5W load

<p>Channel 2; C2 : Drain Source Voltage (VDS) Channel 3; C3 : Feedback voltage (V<sub>FB</sub>) Channel 4; C4 : Current Sense Voltage (V<sub>CS</sub>)</p>	<p>Channel 2; C2 : Drain Source Voltage (VDS) Channel 3; C3 : Feedback voltage (V<sub>FB</sub>) Channel 4; C4 : Current Sense Voltage (V<sub>CS</sub>)</p>
<p>Blanking time to enter burst mode : 18ms</p>	<p>Blanking time to enter burst mode : 18ms</p>
<p><b>Figure 22</b> – Active burst mode @ Vin=85Vac and step from 3.75A to 0.03A</p>	<p><b>Figure 23</b> – Active burst mode @ Vin=265Vac and step from 3.75A to 0.03A</p>
<p>Channel 1; C1 : Output Voltage (V<sub>o</sub>) Output ripple : app. 100mV</p>	<p>Channel 1; C1 : Output Voltage (V<sub>o</sub>) Output ripple : app. 100mV</p>
<p><b>Figure 24</b> – Output ripple at active burst mode @ Vin=85Vac and 0.5W load</p>	<p><b>Figure 25</b> – Output ripple at active burst mode @ Vin=265Vac and 0.5W load</p>

### 11.6 Over load protection – Auto Restart

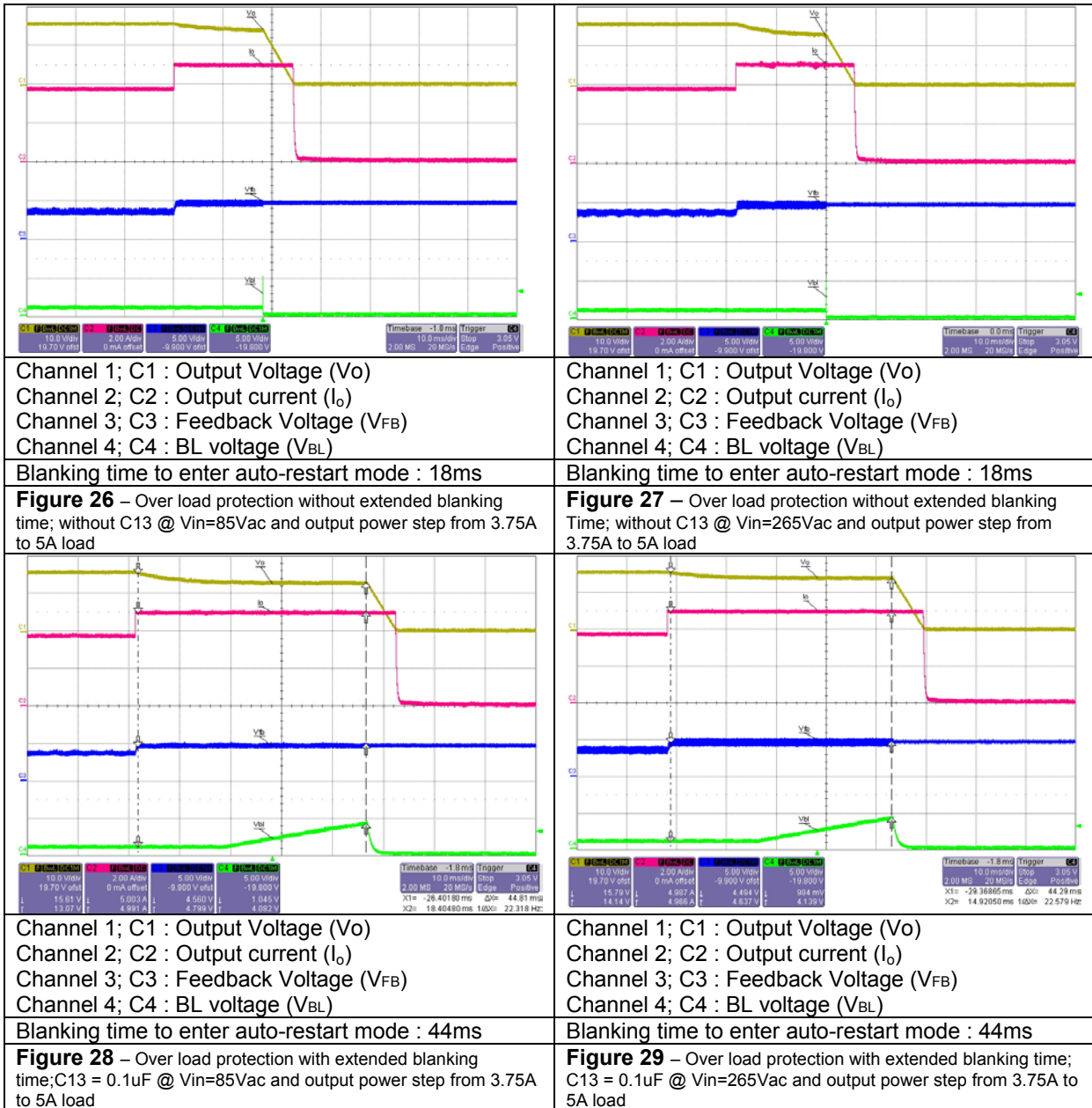

### 11.7 Open loop protection – Auto Restart

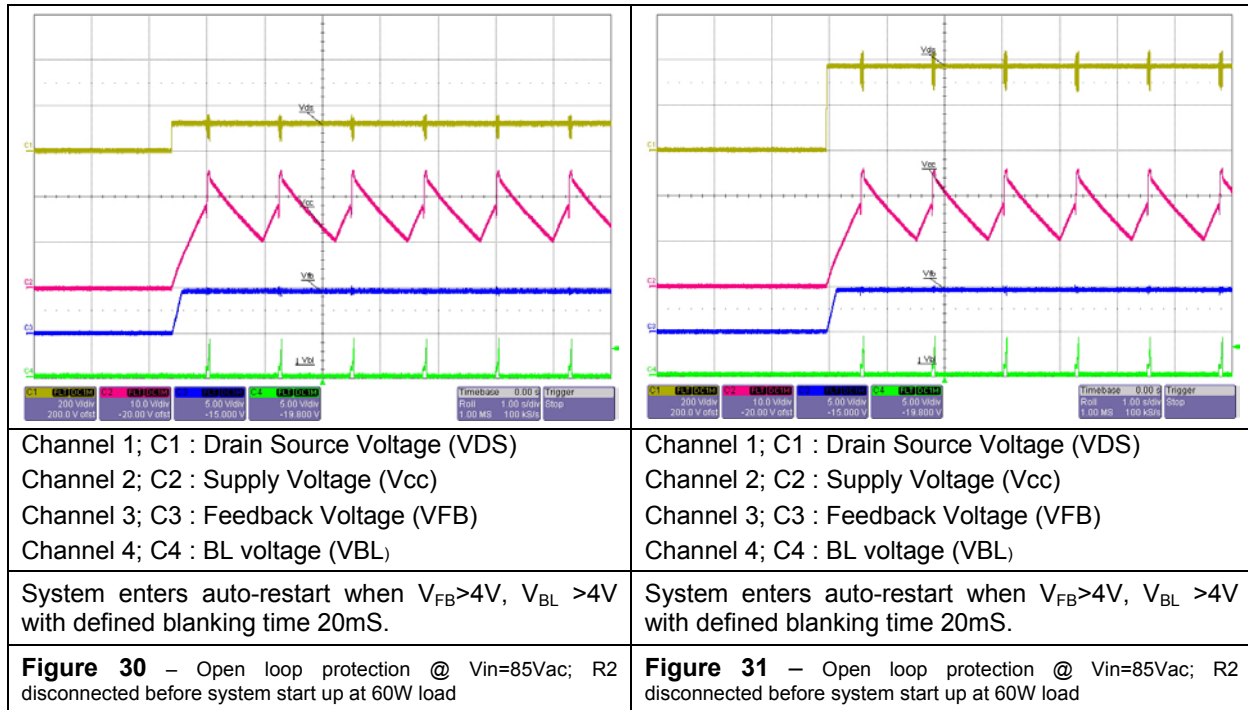

### 11.8 Short optocoupler – Auto Restart

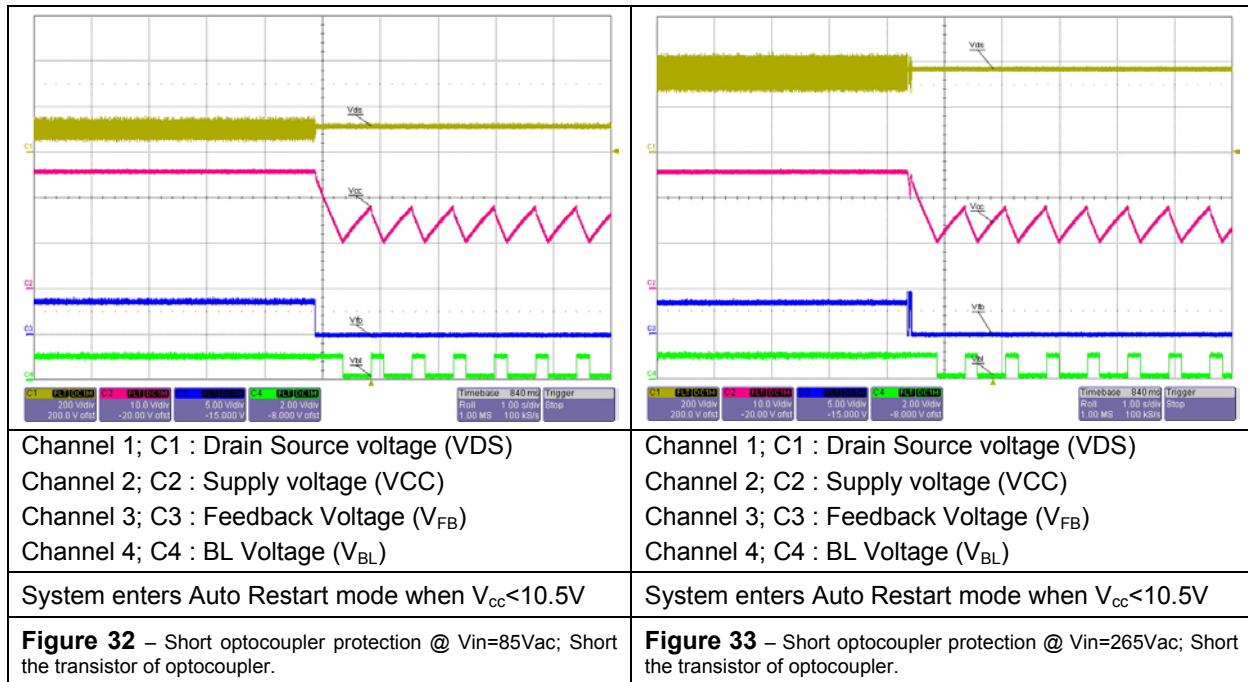



### 11.9 Vcc overvoltage protection - Latched Off

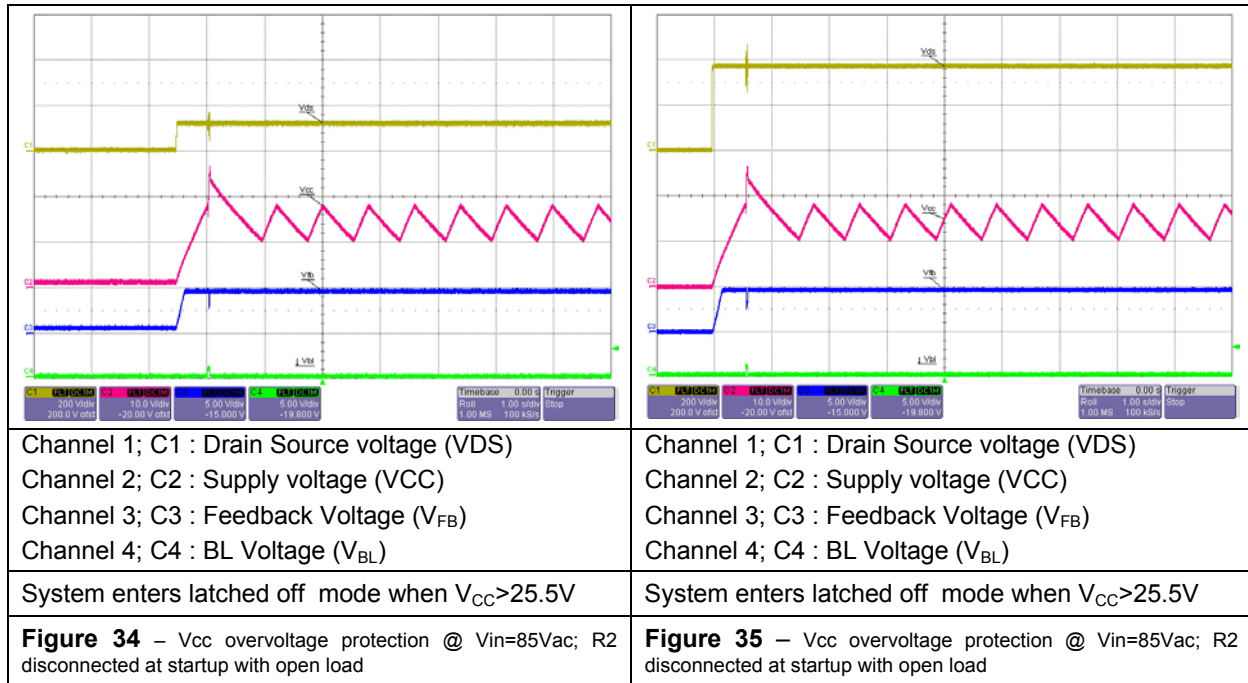

### 11.10 External latched off enable

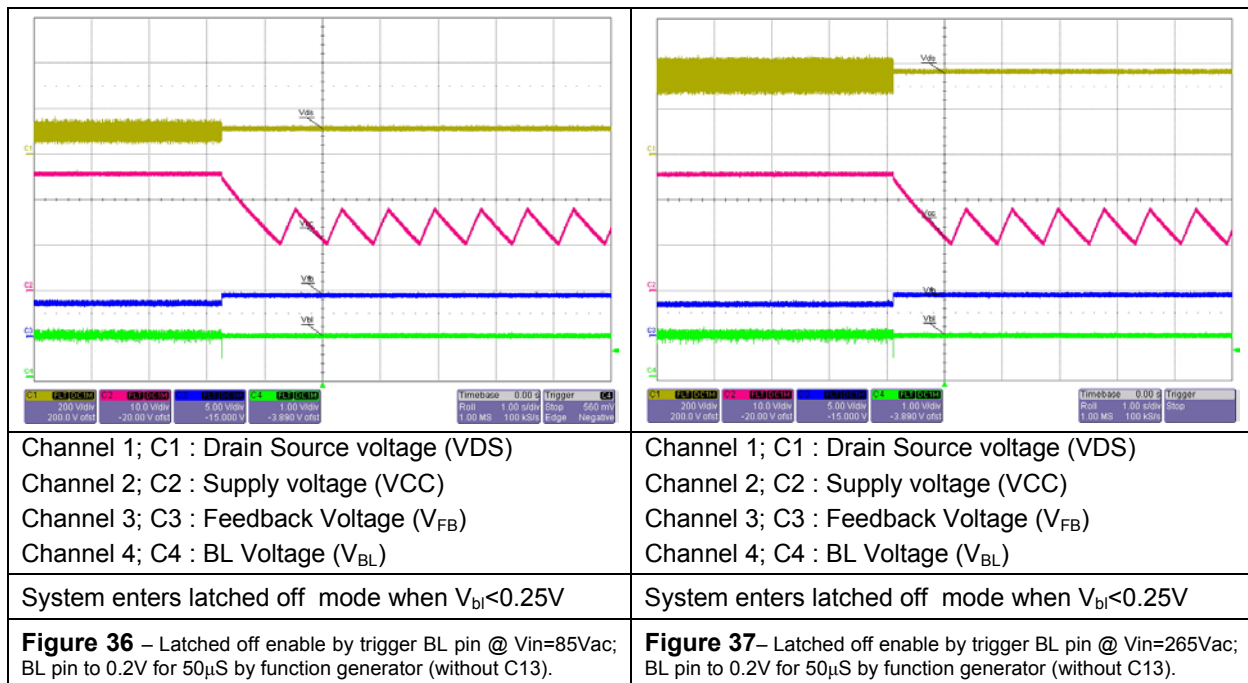

### 11.11 Frequency Jittering

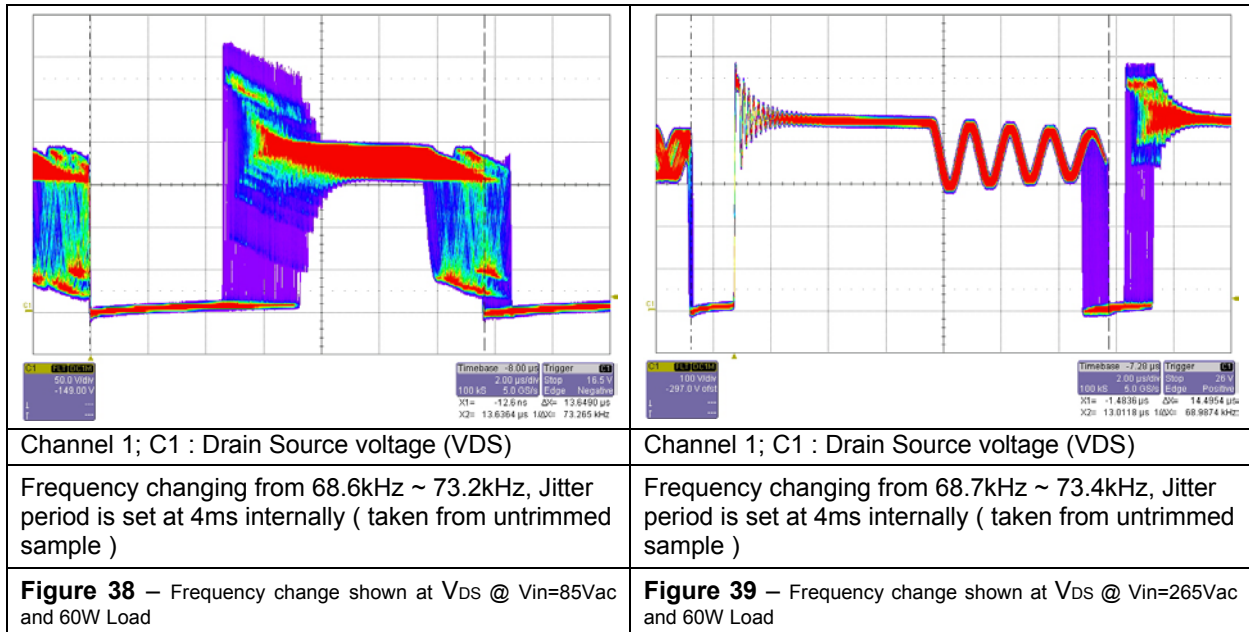

## 12 Appendix

### 12.1 Slope compensation for CCM operation

This demo board is designed in Discontinuous Conduction Mode (DCM) operation. If the application is designed in Continuous Conduction Mode (CCM) operation where the maximum duty cycle exceeds the 50% threshold, it needs to add the slope compensation network. Otherwise, the circuitry will be unstable. In this case, three more components (2 ceramic capacitors C17 / C18 and one resistor R19) are needed to add as shown in the circuit diagram below.

